

Reducing Energy Losses for Fan Applications with V/f control of PMSMs

Abstract. The paper deals with the problem of V/f control of a Permanent Magnet Synchronous Motor without winding dumper for fan applications. Based on stability analysis, an additional stabilizing loop is introduced. Voltage optimization was carried out in order to minimize the input power of PMSM. Simulation results confirmed the validity of the applied solution for fan applications.

Streszczenie. W artykule przedstawiono problem sterowania silnikiem synchronicznym o magnesach trwałych bez klatki tłumiącej według zasady V/f dla napędu wentylatora. Przedstawiono analizę stabilności i dodano dodatkową pętlę stabilizującą prędkość obrotową. Przeprowadzono optymalizację napięcia w celu zminimalizowania energii pobranej przez silnik PMSM. Wyniki symulacyjne potwierdzają słuszność zastosowanej metody dla napędu wentylatorowego. (Redukcja strat energii silnika wentylatora sterowanego według zasady V/f)

Keywords: Energy Losses, V/f control, PMSM, fan applications

Słowa kluczowe: straty energii, sterowanie U/f, silnik synchroniczny o magnesach trwałych, napęd wentylatorowy

Introduction

In the motion control applications use of permanent magnet synchronous motors (PMSM) has significantly increased due to their features such as high efficiency and high power density [1,4]. In servo applications, in order to achieve high dynamic performance in torque, speed and position response the field orientation should be applied in a closed loop control [2]-[4]. The PMSM control requires a position sensor such as an incremental or absolute encoder, which increases the cost and decreases the reliability of the control system. Therefore, PMSM sensorless control is widely used. One of the methods used is a sensorless vector control, which estimates the rotor position by using, for example, the motor's electromotive force [5], or by using a Kalman filter [6,7]. The second method is V/f control in an open loop without rotor position. In applications such as pumps and fans, where a high dynamic is not required, a simple V/f control method can be applied instead of field oriented control [4,8]-[11]. In many applications, interior-type PMSMs with dumping windings are used for open-loop V/f control. Consequently the system is stable. However due to high cost, PMSMs with dumping windings are not often used. PMSMs without dumping windings do not ensure synchronization between the rotor and stator to the control V/f. It is a cause of instability of the system of PMSMs in open loop V/f control. Therefore, additional signals are needed to ensure synchronization and stable operation in V/f control.

In [8]-[10], in order to achieve stability to control V/f with PMSM without dumper windings, a dc-link current feedback was used. Moreover, a coordinate γ - δ frame was introduced in order to find the algorithm which minimize input power to the PMSM.

In [8], a new method of V/f control with PMSM without dumping windings in the rotor is proposed. In this method, stator voltage is calculated in order to maintain constant stator flux. This allows working with constant torque in the full frequency range. To stabilize the system for the full frequency range, additional damping of the rotor is required. This can be achieved by an appropriate modulation of the frequency of the motor [4,8].

In this paper, an extensive simulation study for PMSM without windings dumper for open loop V/f control was carried out, where voltage is calculated in order to maintain a constant stator flux [4]. An analysis of the stability was carried out. Its results show that the PMSM without winding dumper is unstable. An additional stabilizing loop was introduced. Voltage optimization was carried out in order to

minimize the input power of the PMSM. Simulation studies confirmed the validity of the applied solution [4]. They are also a good starting point for future experimental studies.

Mathematical and Simulation Models of PMSM Drive

The basic equations of PMSM on d - q coordinates, where the d -axis is defined along a permanent magnet flux, are defined as:

$$(1) \quad u_d = R_s \cdot i_d + \frac{d\psi_d}{dt} - \omega \cdot \psi_q$$

$$(2) \quad u_q = R_s \cdot i_q + \frac{d\psi_q}{dt} - \omega \cdot \psi_d$$

where u_d i u_q and i_d i i_q are the stator voltage and current components, ψ_d , ψ_q are flux components and ω is the motor angular velocity. R_s is the stator resistance. The flux is properly defined as:

$$(3) \quad \psi_d = L_d \cdot i_d + \lambda_m$$

$$(4) \quad \psi_q = L_q \cdot i_q$$

where λ_m is the permanent magnet flux and L_d , L_q are the stator inductance on both axis. In this paper the surface PMSM is analyzed, for which $L_d = L_q = L$. Motion of the drive is described by equation:

$$(5) \quad J \cdot \frac{d\omega}{dt} = T_e - T_L = \frac{3}{2} \cdot \lambda_m \cdot i_q - T_L$$

Load torque T_L for a typical fan application is defined by:

$$(6) \quad T_L = T_s + k_f \cdot \omega^2$$

where T_s is a static friction torque and k_f is a fan coefficient.

The control system designed on the basis of the equations in the dq -axis allows very good dynamic properties of the drive. In this case, it is however necessary to measure or estimate the position of the motor shaft. In the case of PMSM control in open loop it is advisable to convert the drive equations to the $\delta\gamma$ -axis rotating synchronously with the supply voltage (Fig. 1). After rotation the equations (1)-(6)

$$(7) \quad u_\gamma = 0 = R \cdot i_\gamma + L \cdot \frac{di_\gamma}{dt} - \omega \cdot L \cdot i_\delta + \omega \cdot \lambda_m \cdot \sin \delta$$

$$(8) \quad u_\delta = |u_s| = R \cdot i_\delta + L \cdot \frac{di_\delta}{dt} - \omega_s \cdot L \cdot i_\gamma + \omega \cdot \lambda_m \cdot \sin \delta$$

where ω_s is the supply voltage angular frequency. The relation between current and voltage in dq -axis and $\delta\gamma$ -axis is defined as:

$$(9) \quad \begin{bmatrix} i_d \\ i_q \end{bmatrix} = \begin{bmatrix} \cos \delta & -\sin \delta \\ \sin \delta & \cos \delta \end{bmatrix} \cdot \begin{bmatrix} i_\gamma \\ i_\delta \end{bmatrix}$$

$$(10) \quad \begin{bmatrix} u_d \\ u_q \end{bmatrix} = \begin{bmatrix} -\sin \delta \\ \cos \delta \end{bmatrix} \cdot u_s$$

The load angle δ changes in transient state due to:

$$(11) \quad \frac{d\delta}{dt} = \omega_s - \omega$$

The motor torque is equal to:

$$(12) \quad T_e = \frac{3}{2} \cdot \lambda_m \cdot (i_\gamma \cdot \sin \delta + i_\delta \cdot \cos \delta)$$

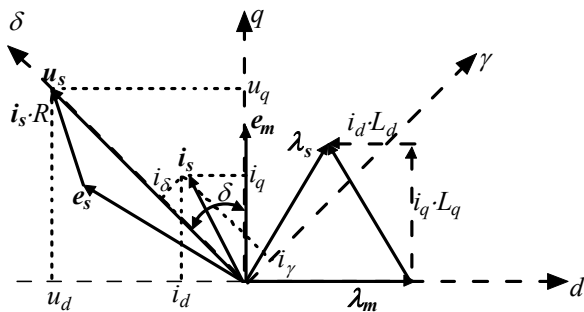

Fig.1. Steady state vector diagram of the PMSM

Stability Analysis of PMSM Drive with V/f Control

The equation set (7)-(12) is nonlinear. To analyze the stability the linearization near the operating point is realized. For the fixed rotor speed ω_0 is required to produce an equal electromagnetic motor torque:

$$(13) \quad T_{L0} + T_s + k_f \cdot \omega_0^2$$

To minimize the motor current, the d - q components value of the current will be:

$$(14) \quad i_{d0} = 0$$

$$(15) \quad i_{q0} = \frac{T_{L0}}{\frac{3}{2} \lambda_m}$$

In this case, the load angle, while omitting the voltage drop at the resistance, according to the diagram of Figure 1 will be equal to:

$$(16) \quad \delta_0 = \arctan \frac{L \cdot i_{q0}}{\lambda_m}$$

The stator voltage should be:

$$(17) \quad u_{s0} = \sqrt{(L \cdot i_{q0})^2 + \lambda_m^2} \cdot \omega_0$$

The current component values on the δ, γ -axes can be determined as:

$$(18) \quad \begin{bmatrix} i_{\gamma 0} \\ i_{\delta 0} \end{bmatrix} = \begin{bmatrix} \cos \delta & \sin \delta \\ -\sin \delta & \cos \delta \end{bmatrix} \cdot \begin{bmatrix} 0 \\ i_{q0} \end{bmatrix} = \begin{bmatrix} i_{q0} \cdot \sin \delta_0 \\ i_{q0} \cdot \cos \delta_0 \end{bmatrix}$$

In steady state, the load angle is not changed, which means that $\omega_{s0} = \omega$.

For the analysis of the linearized model of the drive with PMSM, the state vector \mathbf{x} and the input vector \mathbf{u} are introduced as:

$$(19) \quad \mathbf{x} = [\Delta i_\gamma \quad \Delta i_\delta \quad \Delta \omega \quad \Delta \delta]^T$$

$$(20) \quad \mathbf{u} = [\Delta u_\gamma \quad \Delta u_\delta \quad \Delta \omega_s]^T$$

For such an established linearized model of the PMSM, fan drive stability analysis was performed over the whole range of speeds. For the numerical analysis, the sample drive data were used, based on papers [8]-[11]. Figure 2 shows the loci of the poles as a function of drive speed.

Based on the analysis, two pairs of poles can be highlighted in the drive dynamics. The fast one, related to electromagnetic processes in the motor, is stable for any speed. The other slow pair, shown enlarged in Figure 2, is related to the electromechanical variable. This pair is only stable for low speeds, up to about 20% of the rated speed. Above this speed, the poles are in the right half-plane of the complex plane. Based on the analysis, an order reduction of the system equations is possible. The reduced order state equation has the form:

$$(21) \quad \dot{\mathbf{x}}_R = \mathbf{A}_R \cdot \mathbf{x}_R + \mathbf{B}_R \cdot \mathbf{u}$$

where

$$(22) \quad \mathbf{x}_R = [\Delta \omega \quad \Delta \delta]^T$$

In a simplified analysis it is assumed that stator resistance can be omitted, and then:

$$(23) \quad \mathbf{A}_R = \begin{bmatrix} a_{11} & a_{12} \\ -1 & 0 \end{bmatrix}$$

where

$$(24) \quad a_{11} = -2 \cdot k_f \cdot \omega_0$$

$$(25) \quad a_{12} = \frac{3 \cdot \lambda_m}{2 \cdot J} \cdot (i_{\gamma 0} \cdot \cos \delta_0 - i_{\delta 0} \cdot \sin \delta_0 + \frac{\lambda_m}{L})$$

and

$$(26) \quad \mathbf{B}_R = \begin{bmatrix} b_{11} & b_{12} & b_{13} \\ 0 & 0 & 1 \end{bmatrix}$$

where

$$(27) \quad b_{11} = -\frac{3 \cdot \lambda_m}{2 \cdot J} \cdot \frac{\cos \delta_0}{\omega_0 \cdot L}$$

$$(28) \quad b_{12} = \frac{3 \cdot \lambda_m}{2 \cdot J} \cdot \frac{\sin \delta_0}{\omega_0 \cdot L}$$

$$(29) \quad b_{13} = -\frac{3 \cdot \lambda_m}{2 \cdot J} \cdot \frac{i_{\gamma 0} \cdot \sin \delta_0 + i_{\delta 0} \cdot \cos \delta_0}{\omega_0}$$

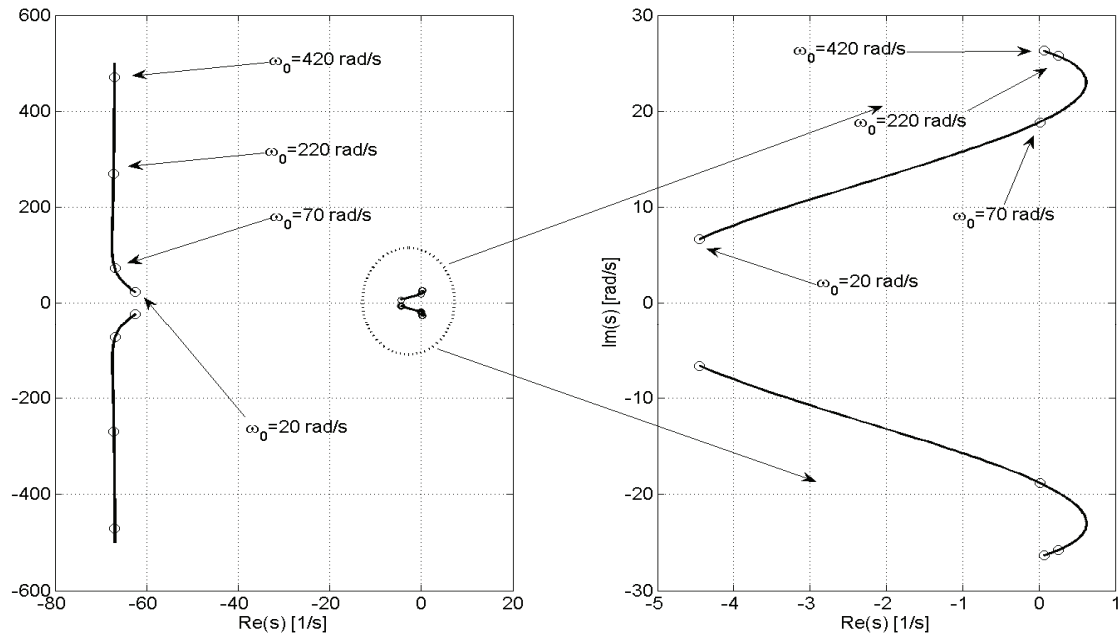

Fig.2. Loci of the drive poles as a function of speed

On the basis of equations (21)-(29), the mechanical subsystem block diagram of the PMSM drive can be represented as shown in Figure 3. In this scheme, only the input is $\Delta\omega_s$ taken into account. Through this input, an additional stabilizing signal to the drive is applied. Voltage vector components are selected with the intention of minimizing losses in the motor.

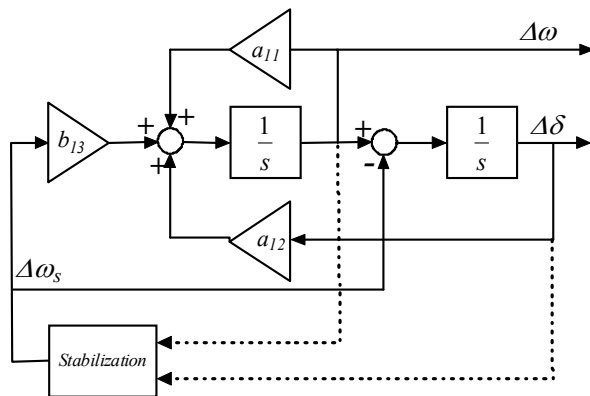

Fig.3. Simplified block diagram

Voltage Control Method

The simulation tests were carried out in Matlab-Simulink. During the tests, the behavior of the speed of PMSM drive was analyzed.

In paper [8], a new V/f control method is proposed for a PMSM without dumping windings in the rotor. In this method the reference stator winding is calculated in order to maintain a constant flux. This allows a constant torque in the full range frequency to be obtained.

For the calculation of the magnitude of the voltage v_s the following equation was used [4,8]:

$$(30) v_s = i_s r_s \cos \varphi_{ui} + \sqrt{e_s^2 + (i_s r_s \cos \varphi_{ui})^2 - (i_s r_s)^2}$$

where: φ_{ui} – the angle between voltage (v_s) and current (i_s) vector, $e_s = \lambda_m \omega$ – electromotive force, λ_m – torque constant, ω_r – reference speed. The current vector is obtained by measuring three phase currents in a fixed coordinate system $\alpha\beta$:

$$(31) i_s = \sqrt{i_\alpha^2 + i_\beta^2}$$

where:

$$(32) i_\alpha = \frac{1}{3}(2i_a - i_b - i_c)$$

$$(33) i_\beta = \frac{1}{\sqrt{3}}(i_b - i_c)$$

The term $i_s \cos \varphi_{ui}$ is calculated from the equation:

$$(34) i_s \cos \varphi_{ui} = \frac{2}{3} \left[i_a \cos \varphi_u + i_b \cos(\varphi_u - 120^\circ) + i_c \cos(\varphi_u + 120^\circ) \right]$$

where: φ_u – voltage vector angle, i_a , i_b , i_c – motor phase currents.

In order to eliminate high frequency distortion in the current i_s a low pass filter was used. The algorithm for calculating the stator voltage v_s is shown in Figure 4.

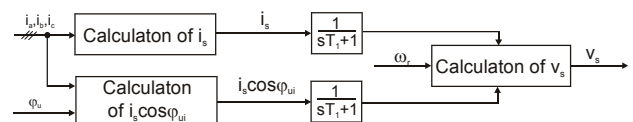

Fig.4. The algorithm for calculating the voltage v_s

Stabilizing Loop

To stabilize the system for the full frequency range, additional damping of the rotor is required. This can be achieved by an appropriate modulation of the frequency of the motor [4,8]. The simplified dynamics model, presented

in section 3 is used for the analysis. This model allows the predicting of how the applied frequency should be modulated to add damping to the system with PMSM. In addition, the speed disturbance is the main cause of the power perturbations for an operating point. Based on this analysis, the applied frequency should be modulated as:

$$(35) \quad \Delta\omega_e = -k\Delta p_e$$

where Δp_e – perturbation of power for an operating point.

This value can be expressed as an electrical power signal after passing through the high pass filter

$$(36) \quad \Delta p_e = \left(1 - \frac{1}{sT+1}\right) p_e = \left(\frac{sT}{sT+1}\right) p_e$$

where input power of the PMSM is given by:

$$(37) \quad p_e = \frac{3}{2} v_s i_s \cos \phi_{ui}$$

The algorithm for calculating the frequency modulation signal $\Delta\omega_e$ is shown in Figure 5.

The block diagram of the open control system V/f with stabilizing loop is shown in Figure 6.

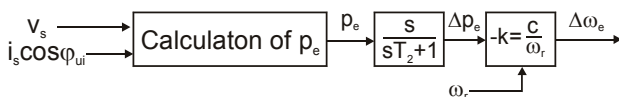

Fig. 5. The algorithm for calculating the frequency modulation signal $\Delta\omega_e$

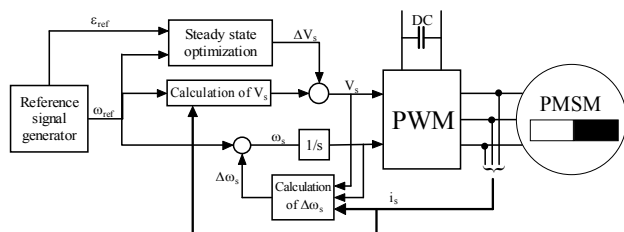

Fig.6. Structure of PMSM drive with stabilizing loop and steady state optimization

Tuning of Stator Voltage to Energy-Optimal Working State

Optimization of the motor in steady state operation can be done in the on-line or off-line structure. The on-line method is based on the measurement of power losses, and uses a search algorithm to tune a control variable to achieve a minimum loss working condition. The optimizing controller does not depend on a loss model and is robust to variations in the motor parameters, such as temperature. Correct measurement of losses is unfortunately often difficult to implement in practice. The off-line method is based on a loss model of the machine. This approach can be used when the losses in the machine can be easily modeled in terms of input signals. This method can usually be easily implemented using look up table methods. This method is proposed in this paper [4].

In a permanent magnet motor with no core loss, a drive that operates at nearly zero d -axis current components will be optimally efficient. In steady state, the amplitude of the motor supply voltage influences the d component of the currents, while a q -axis current component is determined by the load torque [4].

With a fan drive there is an explicit dependence of load torque on the speed. After a series of simulations tests a steady state optimization table is created. The reference acceleration input is used to determine the steady state. The output signal is the fine-grained reference voltage correction. The optimization table is based on power losses in drive. The total power losses consist of winding losses and core losses. Are losses are calculated in detailed motor model.

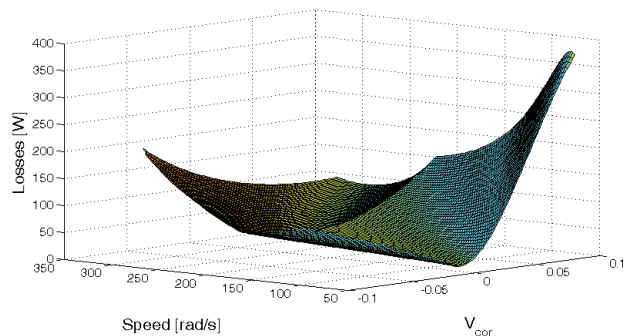

Fig.7. Power losses versus speed and correction voltage

The results of optimization are shown in Fig. 7 and 8. The power losses depend on reference speed and applied voltage correction. The minimum value of power losses is search in the table.

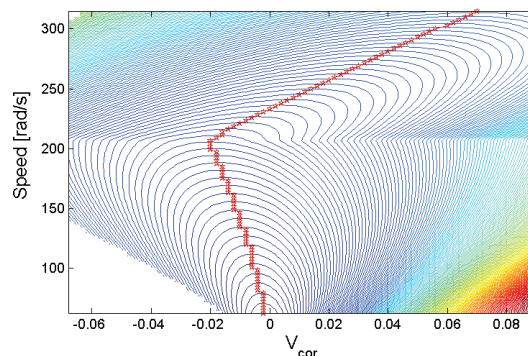

Fig.8. Look-up table for correction voltage reading versus reference speed (minimum losses)

Simulation Results

A motor simulation model was built in Matlab based on standard motor equations (1)-(6). For suitable modeling of the static torque, the static friction Karnopp [12] model was used. A PWM inverter was modeled as an ideal P gain with additional delays. At the present stage of research it is assumed that the current measurement is ideal. The reference speed is generated by a reference signal generator with acceleration and jerk limits [4].

To demonstrate the effectiveness of the proposed method some results of the simulation are presented. The test consists of three phases: startup, changing speed and braking. Figure 9 shows the waveforms for the system without the optimization block [4]. The drive is working properly. Actual speed closely follows the reference speed. The frequency correction signal provides stable operation. The current component in the q -axis is related to the load torque. Unfortunately the d -axis current increases the losses in the drive. The fourth waveform shows the total energy taken by the engine and its losses (winding and iron losses).

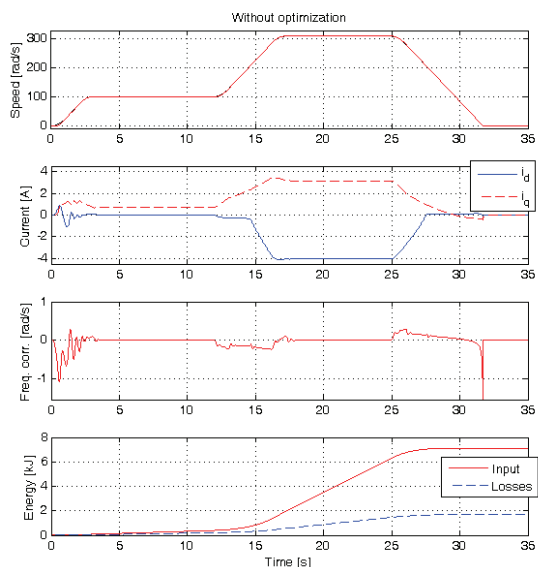

Fig.9. Simulation results for a system without optimization. First: Reference speed (dashed line) and drive speed (solid line); Second: i_q current (dashed line) and i_d current (solid line); Third: Frequency correction; Fourth: Input Energy (solid line) and Losses (dashed line).

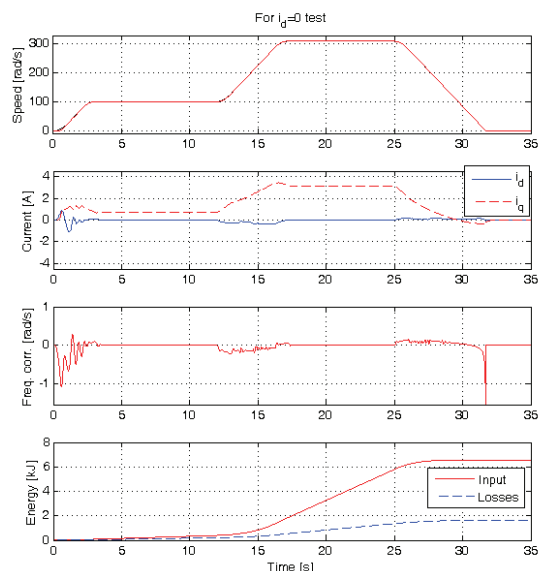

Fig.10. Simulation results for a system with optimization $i_d=0$. First: Reference speed (dashed line) and drive speed (solid line); Second: i_q current (dashed line) and i_d current (solid line); Third: Frequency correction; Fourth: Input Energy (solid line) and Losses (dashed line)

Figure 10 shows the waveforms for the system with the optimization $i_d=0$. Under steady state conditions the d-axis current is reduced to almost zero [4]. Also the reduction of the d-axis current is shown in the dynamic states. This optimization method allows for less energy consumption and lower winding and iron losses compared with the previous method (table 1). Figure 11 shows the waveforms for the system with the optimization for minimum losses:

$$(38) \quad \Delta P = \Delta P_{Cu} + \Delta P_{Fe} = \min$$

For this optimization methods in d-axis current is negative. This allows to reduce the total energy consumption and

reduce losses in the windings and iron. Compared with the previous two cases obtained the lowest total losses.

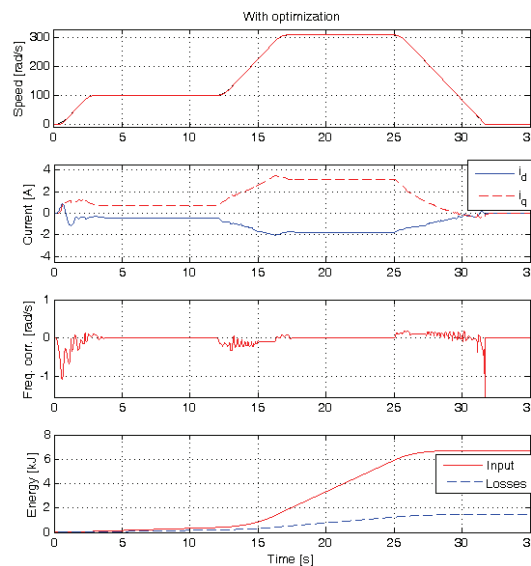

Fig.11. Simulation results for a system with optimization (minimum losses). First: Reference speed (dashed line) and drive speed (solid line); Second: i_q current (dashed line) and i_d current (solid line); Third: Frequency correction; Fourth: Input Energy (solid line) and Losses (dashed line)

Table 1. The values of energy input and losses

Optimization	Input Energy [kJ]	Losses [kJ]
Without	7,11	1,72
$i_d=0$	6,93	1,63
$\Delta P = \min$	6,69	1,49

Conclusions

The method of the PMSM motor control presented in this paper is suitable for applications requiring a low dynamic, like pumps and fans in open loop control. This method does not use position sensors or position estimators. Three methods of PMSM control V/f were presented: without optimisation, with optimisation $i_d=0$ and $\Delta P = \min$. The off-line optimising method is applied. In the case of optimization of the power losses ($\Delta P = \min$) obtained the lowest total energy consumption. The method presented will be implemented in a real industrial drive with low and middle sized fans.

Acknowledgement

This work was partly supported by grant POIG.01.01.02-00-113/09. The new generation of energy-efficient electric drives for pumps and fans.

REFERENCES

- [1] Vas P., Sensorless vector and direct torque control. Oxford University Press, 1998.
- [2] Brock S., and Deskur J., The problem of measurement and control of speed in a drive with an inaccurate measuring position transducer, 10th IEEE International Workshop on Advanced Motion Control, pp. 132-136, 26-28 March 2008.
- [3] Pajchrowski T., Zawirski K.: Application of Artificial Neural Network to Robust Speed Control of Servodrive. IEEE Transaction on Industrial Electronics, Vol.54, No.1, February 2007, pp.200-207.
- [4] Brock S., Pajchrowski T.: Energy-Optimal V/f control of permanent magnet synchronous motors for fan applications, Zeszyty Problemowe-Maszyny Elektryczne nr 92/2011, p. 169-174, BOBRME Komel, Katowice 2011.
- [5] Morimoto S., Kawamoto K., Sanada M., and Takeda Y., Sensorless control strategy for salient-pole PMSM based on

extended EMF in rotating reference frame, *IEEE Trans. Ind. Applicat.*, vol. 38, pp. 1054-1061, July/August 2002.

- [6] Janiszewski D., Extended Kalman filter based speed sensorless PMSM control with load reconstruction, *Vedran Cordic, Kalman Filter InTech*, Vienna 2010.
- [7] S. Bolognani, L. Tubiana, and M. Zigliotto: Extended Kalman filter tuning in sensorless PMSM drives, *IEEE Trans. Ind. Applicat.*, vol. 39, pp. 1741-1747, November/December 2003.
- [8] P.D. Chandana Perera, F. Blaabjerg, J.K. Pedersen, and P. Thogersen, A sensorless, stable V/f control method for permanent-magnet synchronous motor drives, *IEEE Trans. Ind. Applicat.*, vol. 39, pp. 783-791, May/June 2003.
- [9] R.S. Colby, and D.W. Nowotny, An efficiency-optimizing permanent magnet synchronous motor drive, *IEEE Trans. Ind. Applicat.*, vol. 24, pp. 462-469, May/June 1988.
- [10] Y. Nakamura, T. Kudo, F. Ishibashi, and S. Hibino, High-efficiency drive due to power factor control of a permanent

synchronous motor, *IEEE Trans. Power Electron.*, vol. 10, pp. 247-253, March 1995.

- [11] M. Kiuchi, T. Ohnishi, H. Hagiwara, and Y. Yasuda, V/f control of permanent magnet synchronous motors suitable for home appliances by DC-link peak current control method, *International Power Electronic Conference, IPEC*, pp. 567-573, 2010.
- [12] B. Armstrong-Hélouvy, P. Dupont, and C.C. De Wit, A survey of models, analysis tools and compensation methods for the control of machines with friction, *Automatica*, vol. 30, no. 7, pp. 1083-1138, 1994.

Authors: dr inż. Stefan Brock, dr inż. Tomasz Pajchrowski, Politechnika Poznańska, Instytut Automatyki i Inżynierii Informatycznej, ul. Piotrowo 3a, 60-965 Poznań, E-mail: Stefan.Brock@put.poznan.pl, Tomasz.Pajchrowski@put.poznan.pl

SCHEDULE OF EVENTS

February 15, 2012

Deadline for submission of camera-ready 2 page papers

April 15, 2012

Final acceptance of 2 page papers

June 29, 2012

Deadline for submission of the extended papers

SYMPOSIUM SITE

Welcome to Pula !

Each year Istria's largest city, which is located to the south west of the peninsula, warmly greets its visitors. Fans of culture and the arts love to return here, as well as all those who have a curious soul and want to learn more about Istria's rich history. Pula's most important buildings are found in its centre, and the largest is definitely the amphitheatre, the famous "Arena" where gladiators used to fight. Today it is a stage where concerts are often held, as well as film screenings and performances by the greatest Croatian and global artists.

Due to its excellent geographical position, the varied facilities that are adapted to suit each guest, as well as the kilometres of beaches and interesting surroundings, the modern city of Pula is the most interesting destination for tourists in Istria.



All correspondence should be addressed to
Faculty of Engineering
Neven Bulic
Vukovarska 58
51000 Rijeka
Croatia
TEL: +385(0)51 4511478

<http://www.ptetis.put.poznan.pl/XXIIlepc>



XXII SYMPOSIUM ELECTROMAGNETIC PHENOMENA IN NONLINEAR CIRCUITS

**EPNC
2012**

**June 26 - 29, 2012
Pula, Croatia**

